

aquatecnic  
*Wetroom Experts*

# shower tray formers

In Association With



# aquatecnic shower tray formers

Our wide range of Aquatecnic Shower Tray Formers are designed to make wetroom installation fast, easy and secure.

Aquatecnic Shower Tray Formers (also known as hidden shower trays) are always covered with a final floor finish such as tiles or vinyl floor, enabling a continuity of design throughout the wetroom area.

They provide the necessary slope to falls and integrated drainage solutions for both concrete and wooden joisted floor build ups.



Aquatecnic Shower Tray Formers are of the very highest quality and are guaranteed for 25 years. They are sculpted from environmentally friendly birch ply and are extremely strong and reliable.

- ✓ **For Wooden and Concrete Floors**
- ✓ **For Tiled or Vinyl floor finishes**
- ✓ **Traditional and Linear style drainage options**
- ✓ **Range of sizes available from stock**
- ✓ **Made to measure service available to exactly match your requirements**
- ✓ **Very strong with high compressive strength**
- ✓ **Environmentally friendly birch ply construction from renewable sources.**

● **We're Here to Help** | If you need any further advice please do not hesitate to contact us.

### Aquatecnic Linear Drainage System

Our Linear Drainage System can be supplied as part of a Linear Shower Tray Former Package (see right) or as a stand alone product e.g. in a screeded floor build up.

#### Benefits Include :-

- Strong**                      Manufactured from Stainless Steel
- Efficient**                 With preformed gradient towards trap
- Versatile**                5 different trap options available to suit every requirement
- Adaptable**              Adjustment screws included to ensure grating is at the correct height
- Secure**                    One of the only linear channels to include a clamping plate for a perfect seal onto tanking membrane
- Low Profile**             Main channel is only 18mm deep
- Complete**                Comes with all fittings including stainless steel fixing screws
- Range of Sizes**         Available from stock in 5 standard sizes
- Choice**                    Six standard grate designs (see back page)
- Bespoke Service**        Formers, linear channels and gratings can all be custom fabricated in the UK for that special one off design



#### Standard Sizes

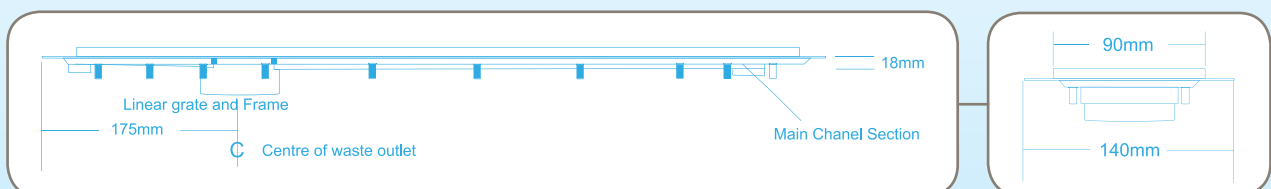

Code	Total Length	Total Width	Grating Length	Grating Width
Aqua LD 300	350mm	140mm	300mm	90mm
Aqua LD 700	750mm	140mm	700mm	90mm
Aqua LD 800	850mm	140mm	800mm	90mm
Aqua LD 900	950mm	140mm	900mm	90mm
Aqua LD 1000	1050mm	140mm	1000mm	90mm

## Aquatecnic Linear Shower Tray Former

Our Linear Shower Tray Formers are manufactured from 24mm thick birch ply. The slope to falls is cut into the tray to create a gradient of approx. 16mm between the front edge of the tray and the linear waste. The package we supply consists of a linear waste support, a high quality stainless steel drainage channel with membrane clamping plate, fully trapped waste outlet (46 litres / min), the shower tray former itself and a large choice of high quality stainless steel linear gratings (see back page).

### Stock Sizes

Code	A	B	C	D	E
Aqua Lin 8/10	1000mm	800mm	900mm	700mm	180mm
Aqua Lin 9/10	1000mm	900mm	1000mm	800mm	180mm
Aqua Lin 9/12	1200mm	900mm <td 1000mm	800mm	180mm	
Aqua Lin 9/135	1350mm	900mm	1000mm	800mm	180mm
Aqua Lin 9/15	1500mm	900mm	1000mm	800mm	180mm
Aqua Lin 10/10	1000mm	1000mm	1100mm	900mm	180mm
Aqua Lin 10/12	1200mm	1000mm	1100mm	900mm	180mm
Aqua Lin 12/10	1000mm	1200mm	1220mm	1000mm	180mm
Aqua Lin 12/12	1200mm	1200mm	1220mm	1000mm	180mm

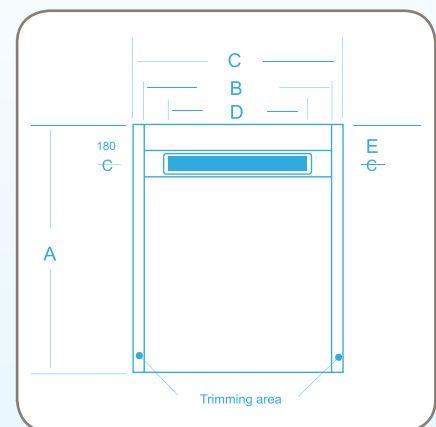

### Made to Measure

If our stock size formers are not exactly what you need, we can fabricate custom size linear formers, double ended formers and even custom made drainage channels. So whatever your design calls for, if it can be made, we'll make it. Please contact us at an early stage for further advice on the ideal specification for your project.

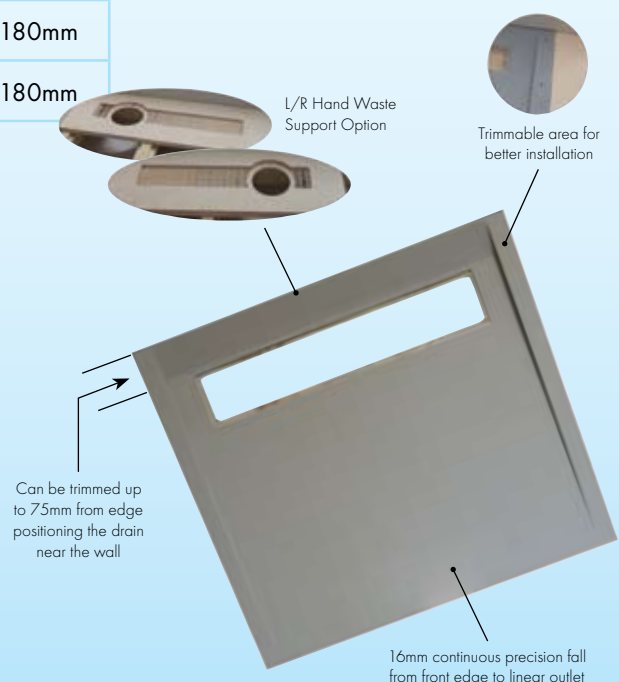

## Aquatecnic Traditional Shower Tray Formers

Our Traditional Shower Tray Formers are manufactured from 24mm thick birch ply. The slope to falls is cut into the tray to create a gradient of approx. 18mm between the perimeter of the tray and the waste. The package we supply consists of a waste support, a fully trapped waste outlet (46 litre / min.), the shower tray former itself and a large choice of high quality stainless steel tilesets (see back page).

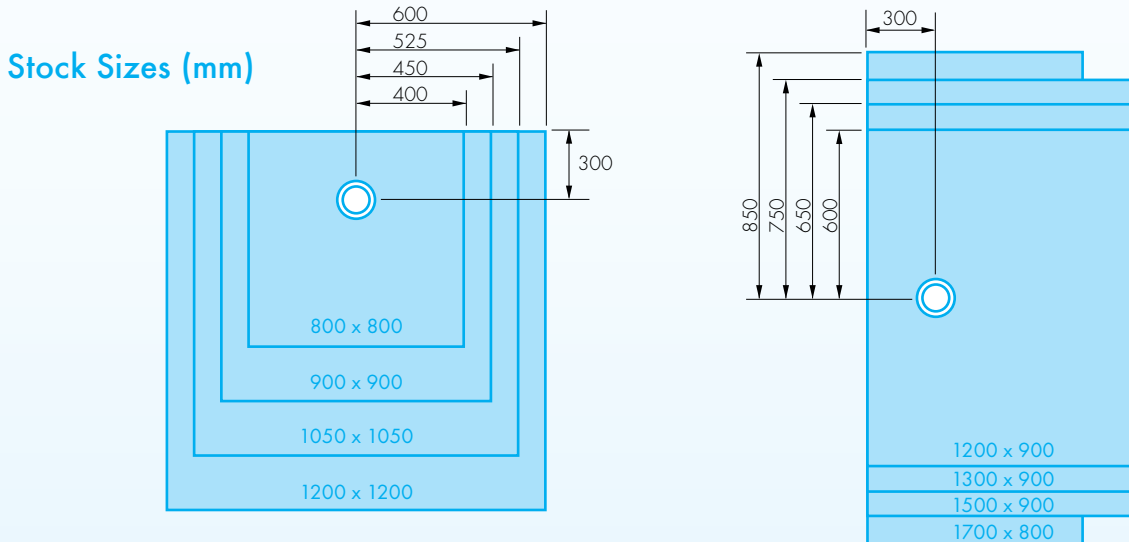

## Made to Measure Service

With our made to measure service you can order the precise shape and size of shower tray that you need. Simply send us your drawing showing the overall dimensions, waste centre position (min. 300mm from edge) and any flat areas or out of square angles required. We offer a full and free advice service in relation to planning your wetroom tray, so please contact us at an early stage for further guidance on the ideal specification for your project.

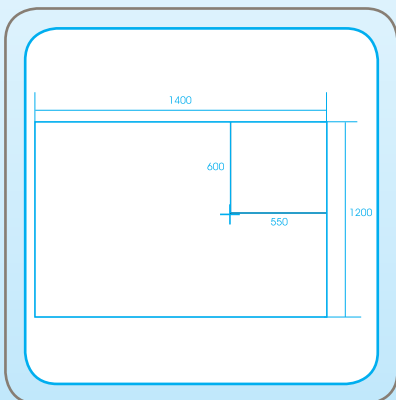

The Drawing



The Tray

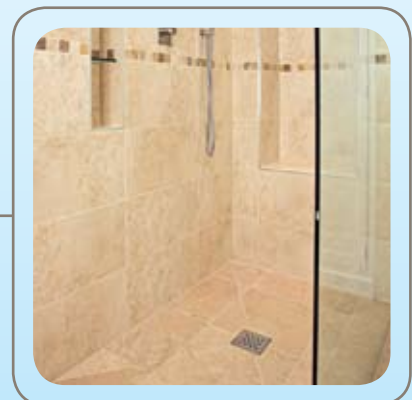

The Finished Job

## Aquatecnic Shower Tray Formers | Finishing Touches

### Cover Plates (for vinyl finishes)



### Tilesets



### Linear Gratings

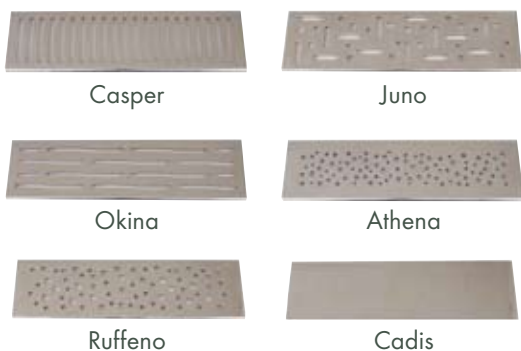

### Gratings and Options

We offer a wide range of gratings and tilesets and can also fabricate bespoke designs if required. For vinyl floor finishes we offer a choice of stainless steel or white plastic cover plates. For tiled floors we have 12 different tileset / grating options, each available in brushed or highly polished finishes

### Waste Outlets

As standard all of our Traditional and Linear Shower Tray Formers are supplied with a high quality wetroom waste outlet with an integral 50mm water trap. This trap is available with either a horizontal or vertical waste pipe attachment and has a drainage capacity of 46 LPM. We can also offer untrapped gulleys for connection to a waste pump, wastes with a 60 LPM flow rate, Caroflow Lo-Line traps (only 95mm deep) and wastes with a 75mm water trap.

### Tanking

All shower tray formers and wetroom floors must be tanked with an approved wetroom tanking system conforming to the requirements of ETAG22 "Liquid applied watertight coverings for wetrooms with wearing surface". Our own Aquaproof System meets this requirement and is available in kit form to suit the shower tray formers and linear formers.

**KÖSTER**  
aquatecnic

*Waterproofing for Professionals*

The Mount Sydney, Craigs Road,  
Dumfries DG1 4EU

T: 01387 270252

E: [info@kosteruk.com](mailto:info@kosteruk.com)

[www.wetroomexperts.co.uk](http://www.wetroomexperts.co.uk)

Aquatecnic supply a full range of wetroom products including; wetroom tanking, shower enclosures, underfloor heating and shower outlets. For further details please visit [www.wetroomexperts.co.uk](http://www.wetroomexperts.co.uk)